

LEVEL 2

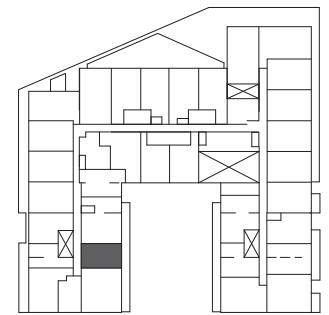

LEVEL 3

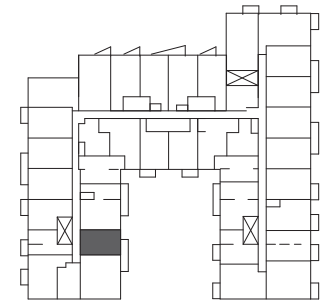

LEVEL 4

**1107
MAIN**
HAMILTON

1 BED

B441

SUITE: 441 SQ.FT. TERRACE: 81 SQ.FT. TOTAL: 522 SQ.FT. | UNITS: #203, 305

SUITE: 440 SQ.FT. BALCONY: 51 SQ.FT. TOTAL: 491 SQ.FT. | UNIT: #405

IN8

Illustrations are concept only. Plans and specifications are subject to change without notice. Actual floor space may vary from stated floor area. See sales representative for more information. E. & O. E.

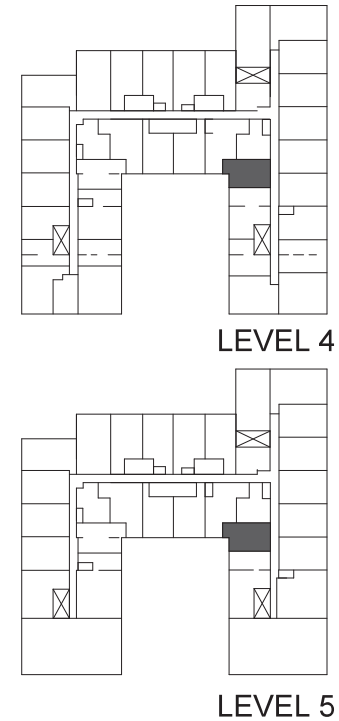
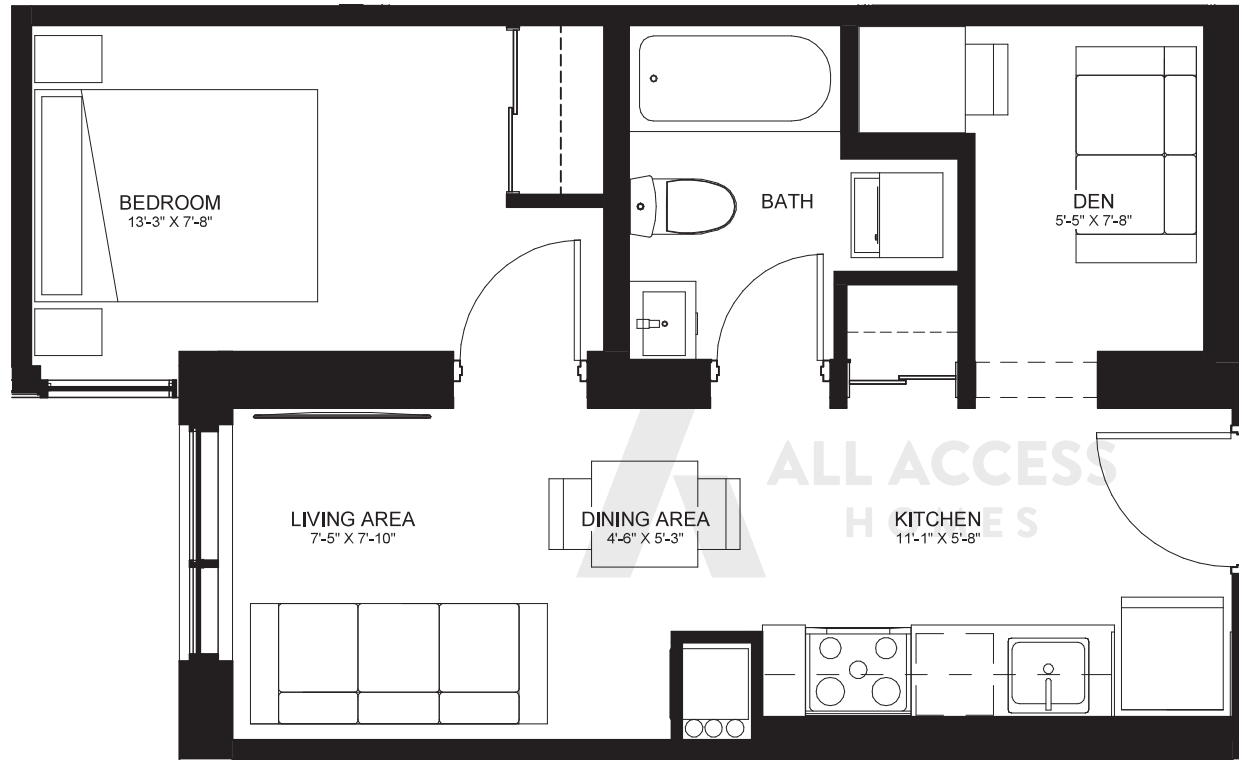

**1107
MAIN**
HAMILTON

1 BED + DEN

C470

SUITE: 470 SQ.FT. | UNITS: #433, 524

IN8

Illustrations are concept only. Plans and specifications are subject to change without notice. Actual floor space may vary from stated floor area. See sales representative for more information. E. & O. E.

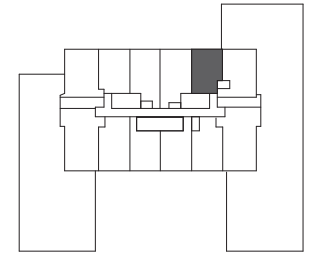
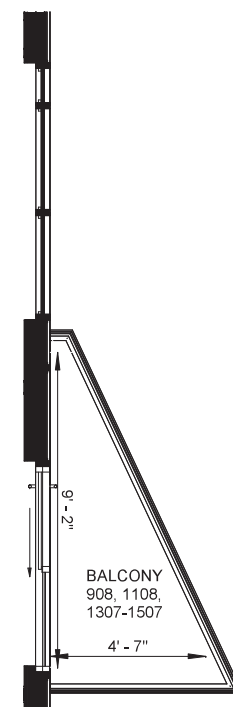
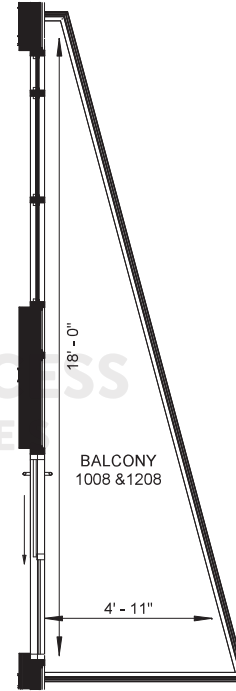
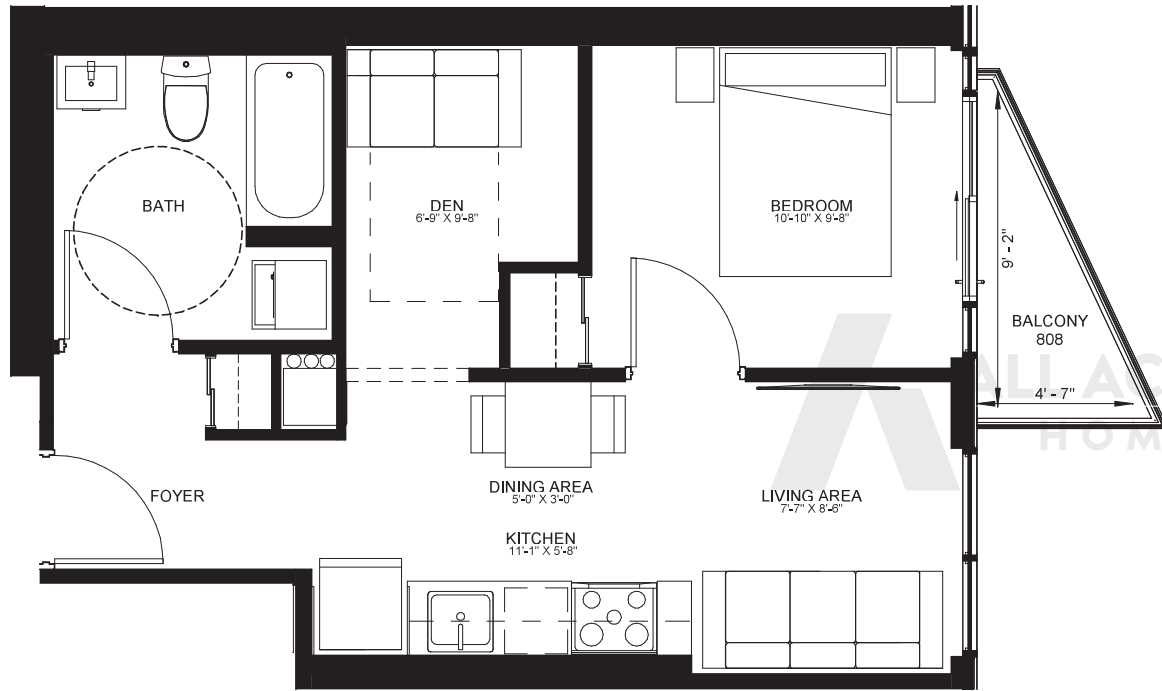

LEVEL 8

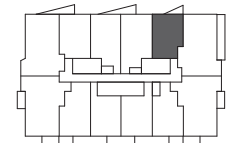

LEVEL 9-12

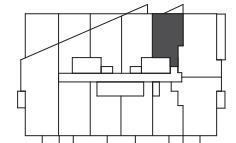

LEVEL 13

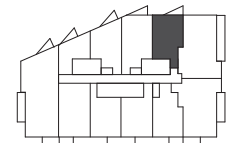

LEVEL 14-15

1 BED + DEN

C500

SUITE: 500 SQ.FT.

BALCONY: 32 SQ.FT.

TOTAL: 532 SQ.FT. | UNIT: #808

SUITE: 500 SQ.FT.

BALCONY: 64 SQ.FT.

TOTAL: 564 SQ.FT. | UNITS: #1008, 1208

SUITE: 501 SQ.FT.

BALCONY: 34 SQ.FT.

TOTAL: 535 SQ.FT. | UNITS: #908, 1108, 1307-1507

1107
MAIN
HAMILTON

IN8

Illustrations are concept only. Plans and specifications are subject to change without notice. Actual floor space may vary from stated floor area. See sales representative for more information. E. & O. E.

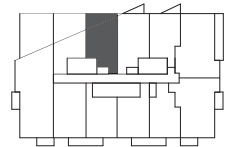
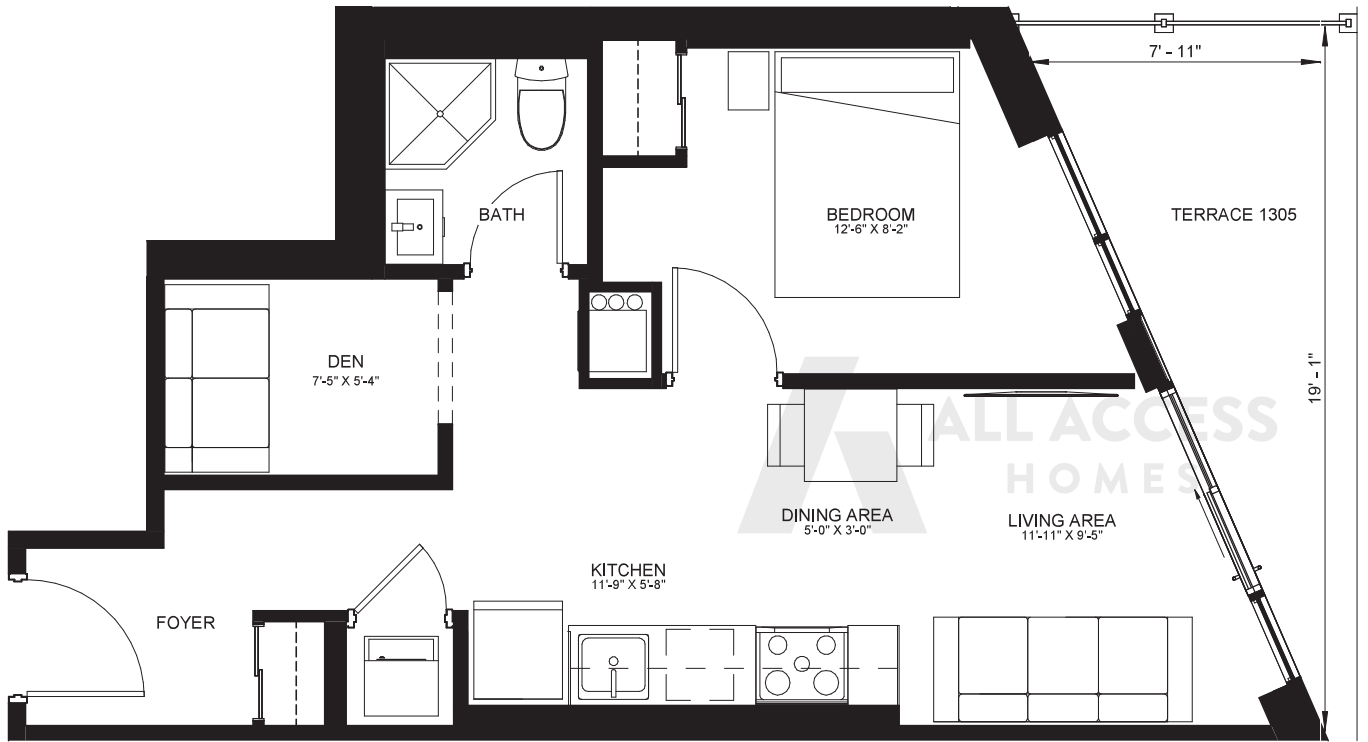

LEVEL 13

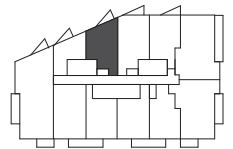

LEVEL 14-15

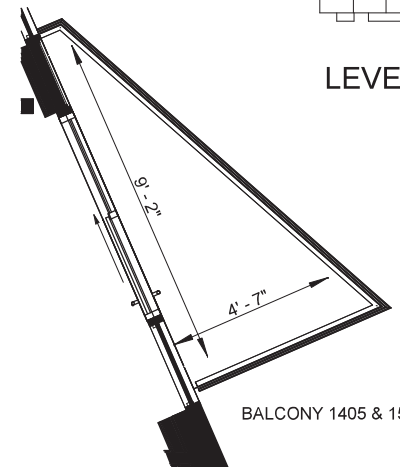

BALCONY 1405 & 1505

**1107
MAIN**
HAMILTON

1 BED + DEN

C507

SUITE: 507 SQ.FT. TERRACE: 115 SQ.FT. TOTAL: 622 SQ.FT. | UNIT: #1305

SUITE: 507 SQ.FT. BALCONY: 34 SQ.FT. TOTAL: 541 SQ.FT. | UNITS: #1405-1505

IN8

Illustrations are concept only. Plans and specifications are subject to change without notice. Actual floor space may vary from stated floor area. See sales representative for more information. E. & O. E.

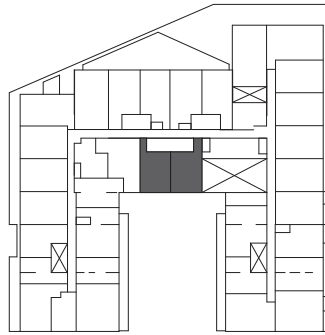
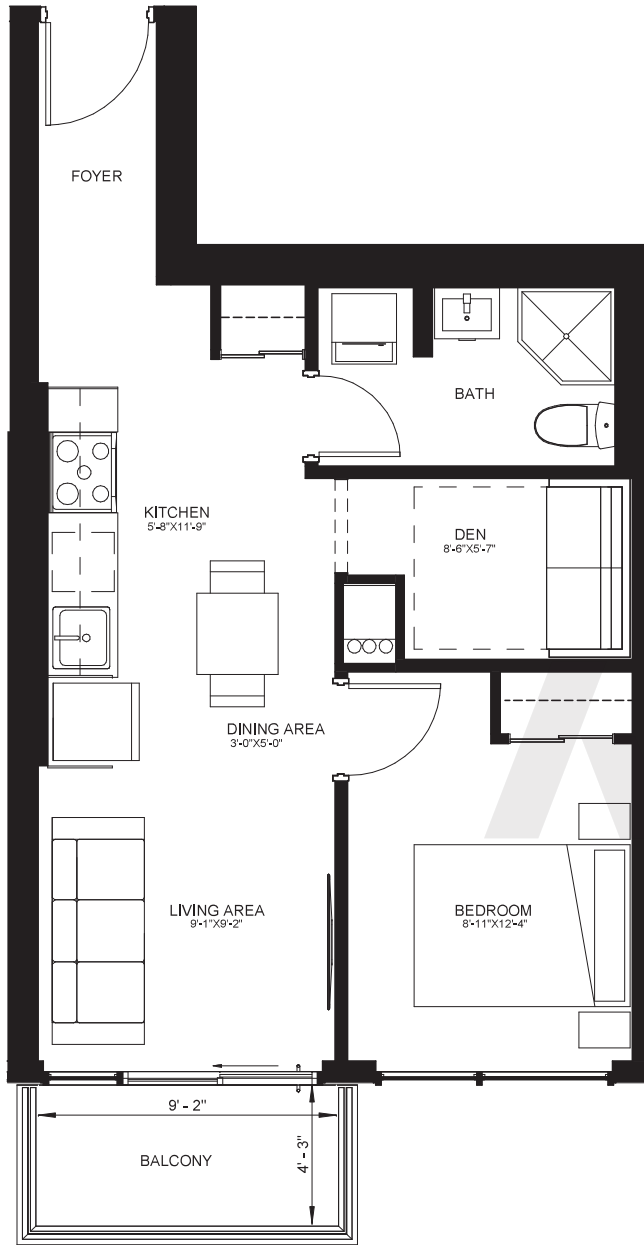

LEVEL 3

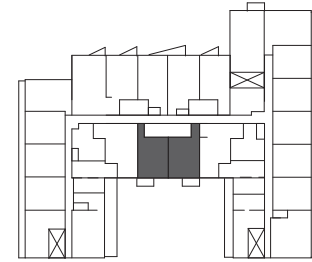

LEVEL 6

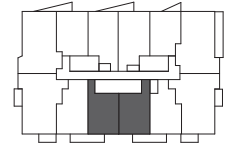

LEVEL 9-12

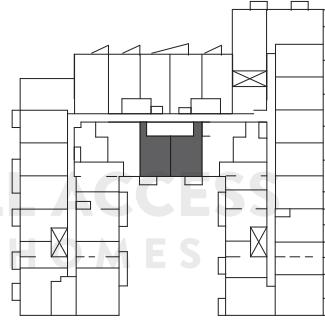

LEVEL 4

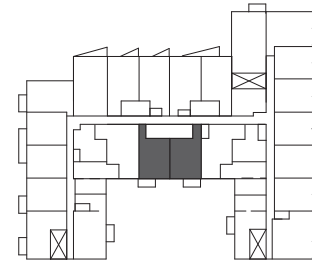

LEVEL 7

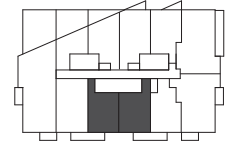

LEVEL 13

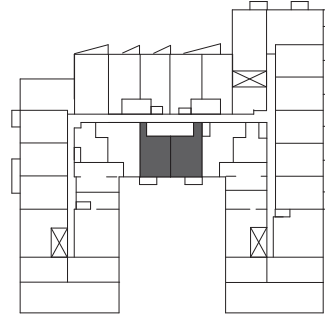

LEVEL 5

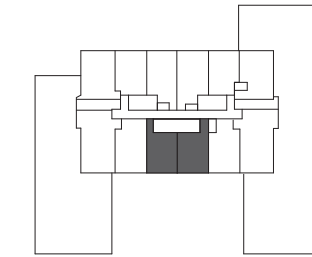

LEVEL 8

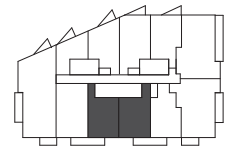

LEVEL 14-15

1 BED + DEN

C518

SUITE: 518 SQ.FT.

BALCONY: 51 SQ.FT.

TOTAL: 569 SQ.FT.

UNITS: #301-1501

SUITE: 521 SQ.FT.

BALCONY: 51 SQ.FT.

TOTAL: 572 SQ.FT.

UNITS: #912-1212

SUITE: 522 SQ.FT.

BALCONY: 51 SQ.FT.

TOTAL: 573 SQ.FT.

UNITS: #812, 1311-1511

SUITE: 524 SQ.FT.

BALCONY: 51 SQ.FT.

TOTAL: 574 SQ.FT.

UNITS: #333, 435, 526-726

Illustrations are concept only. Plans and specifications are subject to change without notice. Actual floor space may vary from stated floor area. See sales representative for more information. E. & O. E.

1107
MAIN
HAMILTON

IN8

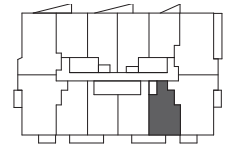
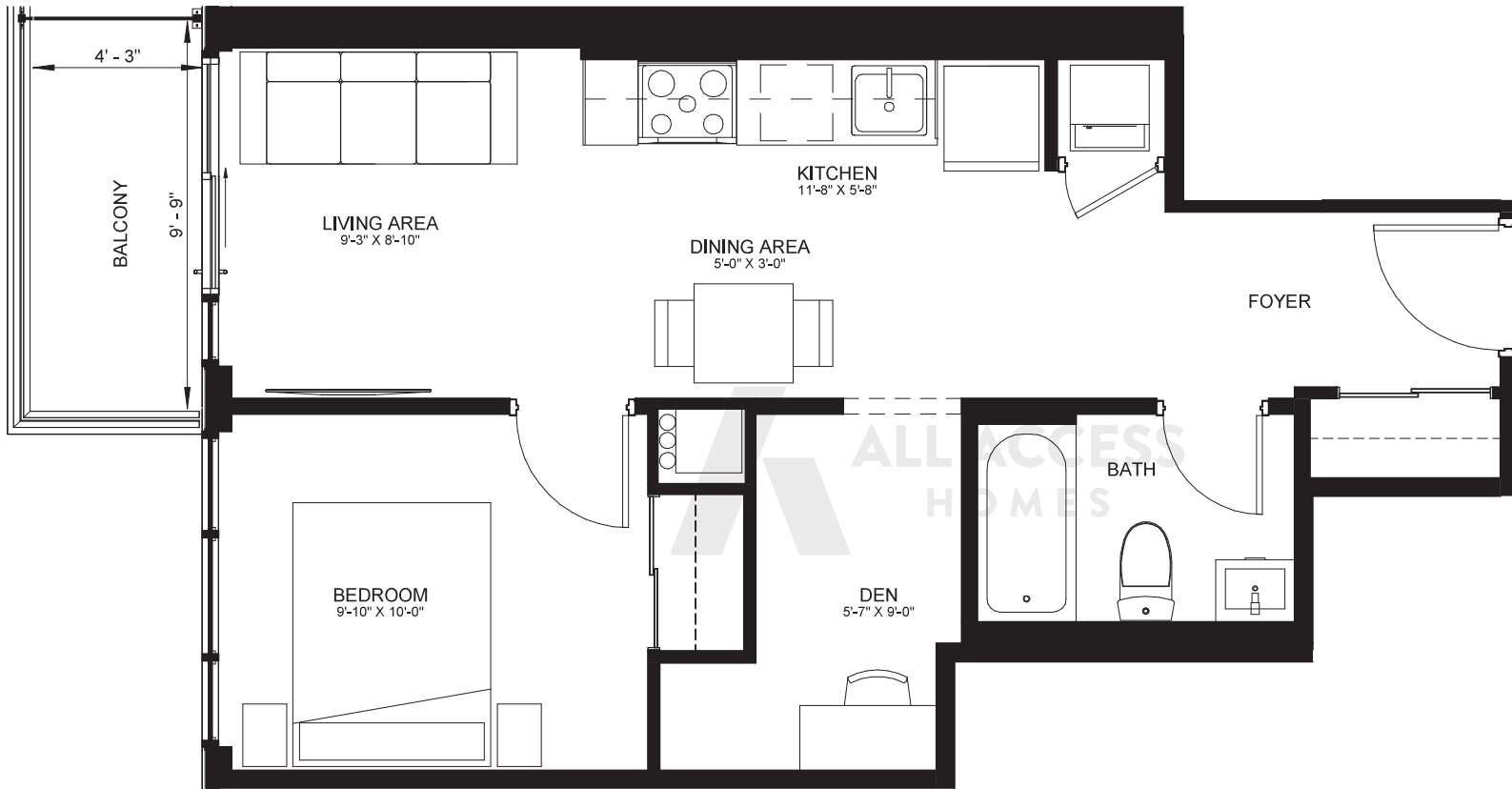

LEVEL 9-12

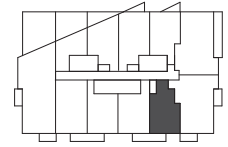

LEVEL 13

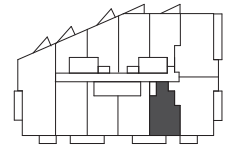

LEVEL 14-15

**1107
MAIN**
HAMILTON

1 BED + DEN

C527

SUITE: 527 SQ.FT.

BALCONY: 51 SQ.FT.

TOTAL: 578 SQ.FT. | UNITS: #911-1211, 1310-1510

IN8

Illustrations are concept only. Plans and specifications are subject to change without notice. Actual floor space may vary from stated floor area. See sales representative for more information. E. & O. E.

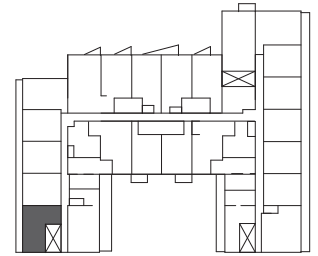
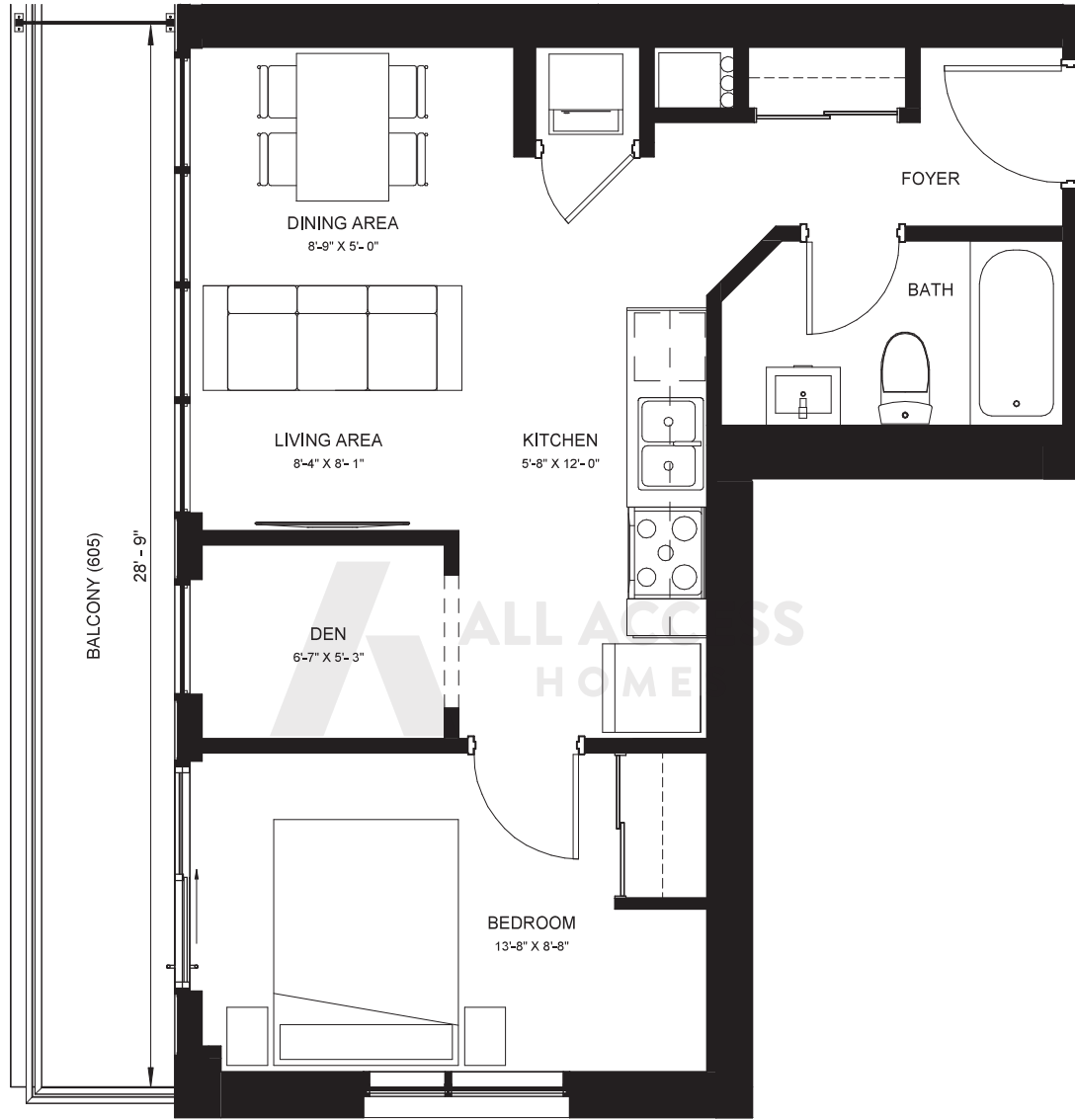

LEVEL 6

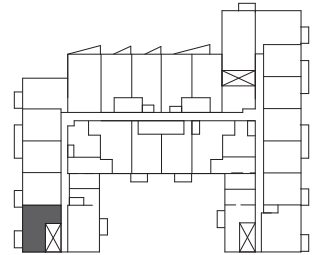

LEVEL 7

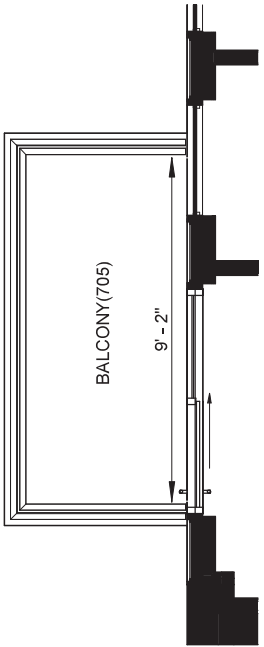

1 BED + DEN

C548

SUITE: 548 SQ.FT. BALCONY: 131 SQ.FT. TOTAL: 679 SQ.FT. | UNIT: #605

SUITE: 548 SQ.FT. BALCONY: 51 SQ.FT. TOTAL: 599 SQ.FT. | UNIT: #705

IN8

1107
MAIN
HAMILTON

Illustrations are concept only. Plans and specifications are subject to change without notice. Actual floor space may vary from stated floor area. See sales representative for more information. E. & O. E.

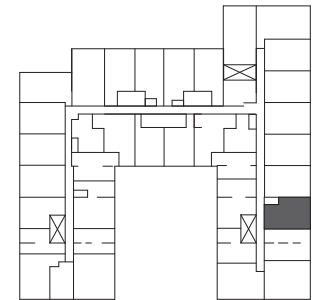
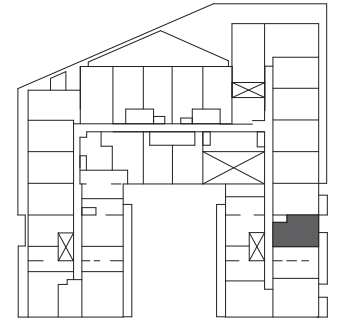
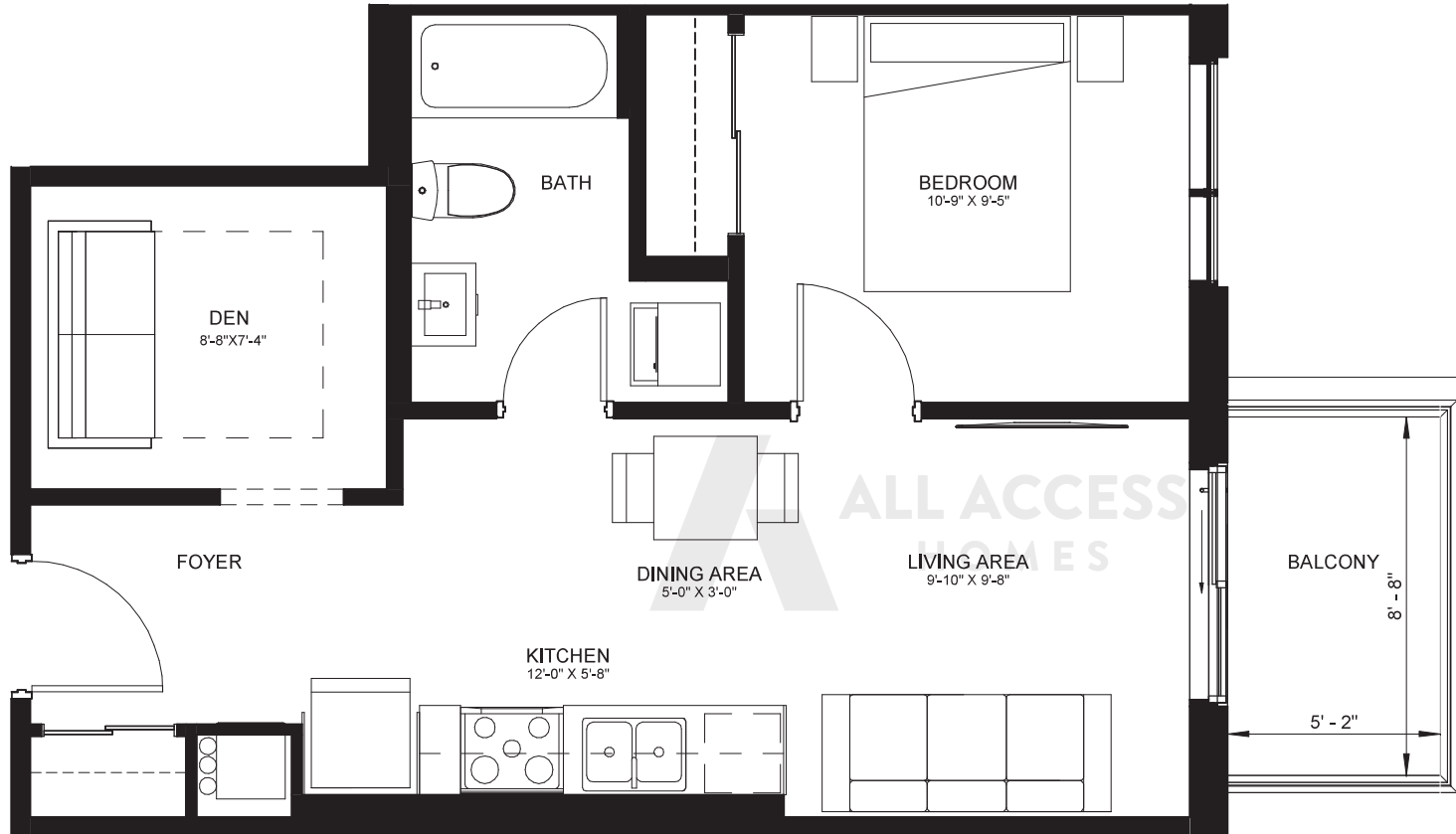

**1107
MAIN**
HAMILTON

1 BED + DEN

C555

SUITE: 555 SQ.FT.

BALCONY: 51 SQ.FT.

TOTAL: 606 SQ.FT. |

UNITS: #327-427

IN8

Illustrations are concept only. Plans and specifications are subject to change without notice. Actual floor space may vary from stated floor area. See sales representative for more information. E. & O. E.

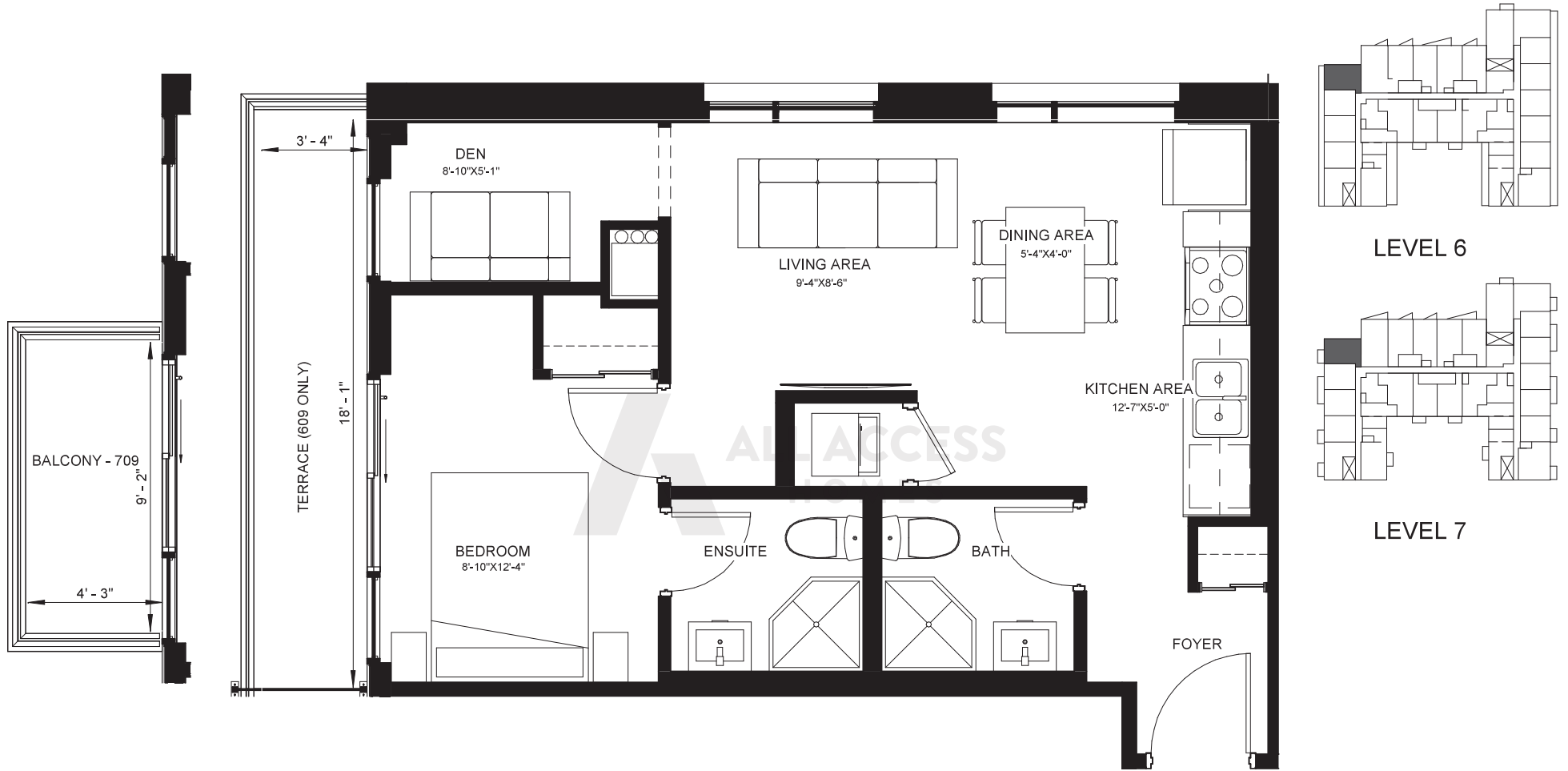

1 BED + DEN

D574

SUITE: 574 SQ.FT. TERRACE: 84 SQ.FT. TOTAL: 658 SQ.FT. | UNIT: #609

SUITE: 565 SQ.FT. BALCONY: 51 SQ.FT. TOTAL: 616 SQ.FT. | UNIT: #709

IN8

**1107
MAIN**
HAMILTON

Illustrations are concept only. Plans and specifications are subject to change without notice. Actual floor space may vary from stated floor area. See sales representative for more information. E. & O. E.



NORTH

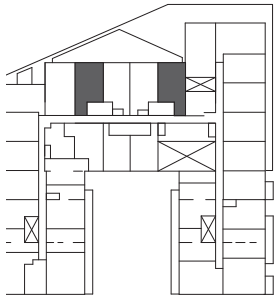

LEVEL 3

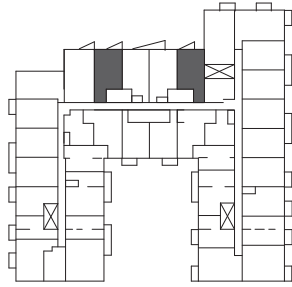

LEVEL 4

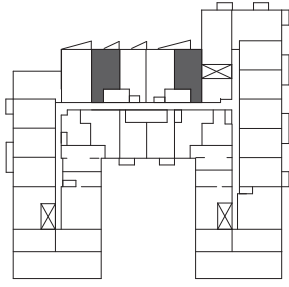

LEVEL 5

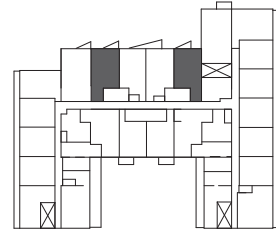

LEVEL 6

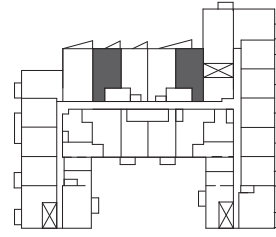

LEVEL 7

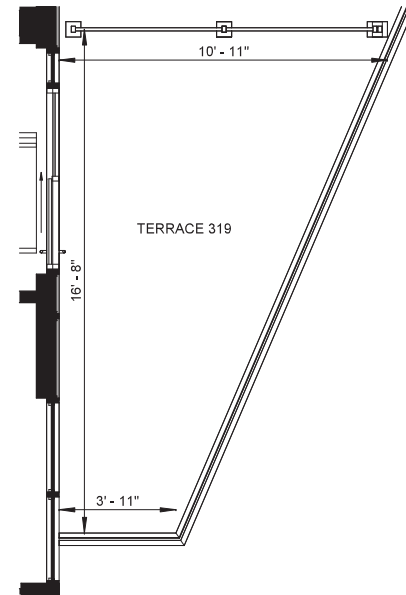

TERRACE 319

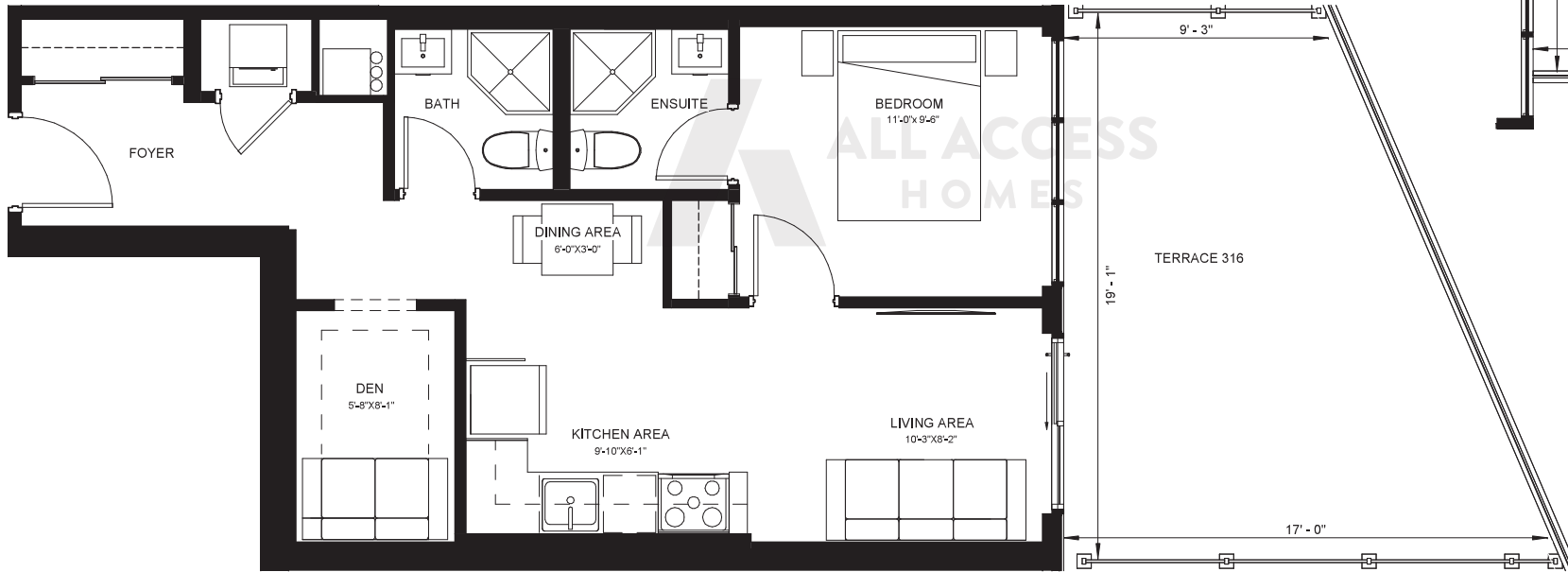

TERRACE 316

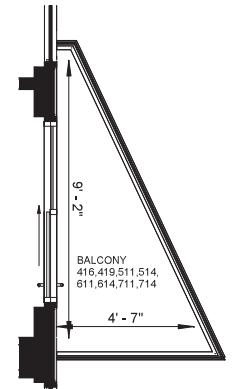

BALCONY
416, 419, 511, 514,
611, 614, 711, 714

**1107
MAIN**
HAMILTON

1 BED + DEN

D599b

SUITE: 599 SQ.FT.
SUITE: 598 SQ.FT.
SUITE: 599 SQ.FT.
SUITE: 598 SQ.FT.

TERRACE: 265 SQ.FT.
TERRACE: 133 SQ.FT.
BALCONY: 32 SQ.FT.
BALCONY: 32 SQ.FT.

TOTAL: 864 SQ.FT. | UNITS: #316
TOTAL: 731 SQ.FT. | UNITS: #319
TOTAL: 631 SQ.FT. | UNITS: #416, 511-711
TOTAL: 630 SQ.FT. | UNITS: #419, 514-714

Illustrations are concept only. Plans and specifications are subject to change without notice. Actual floor space may vary from stated floor area. See sales representative for more information. E. & O. E.

IN8

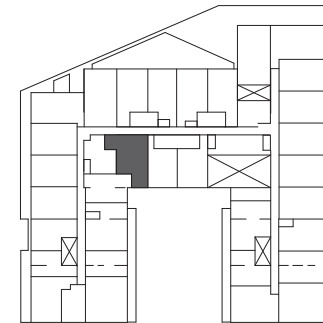
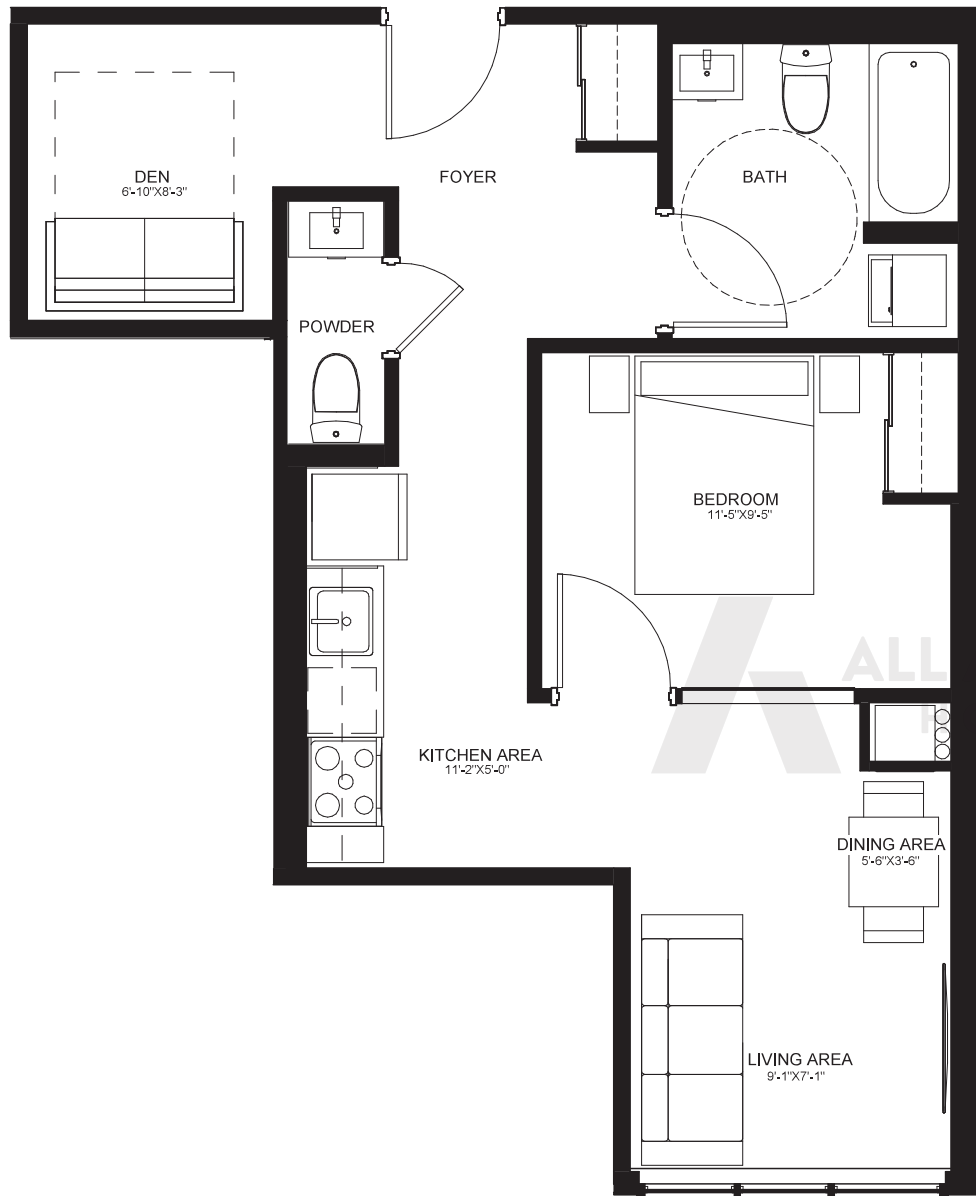

LEVEL 3

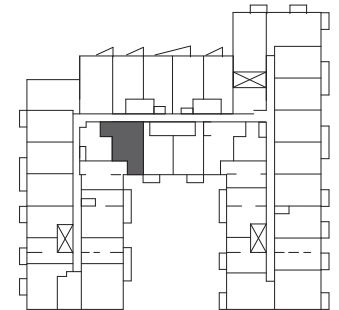

LEVEL 4

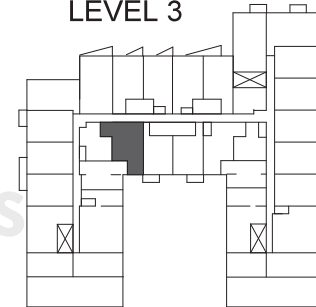

LEVEL 5

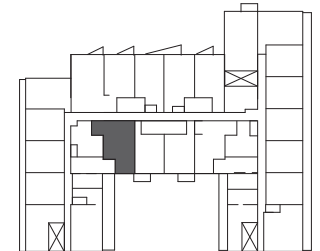

LEVEL 6

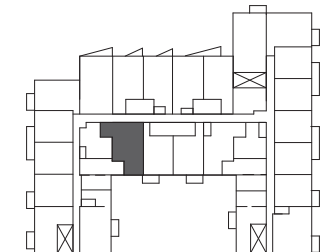

LEVEL 7

**1107
MAIN**
HAMILTON

1 BED + DEN

D626

SUITE: 626 SQ.FT. | UNITS: #302, 502, 702

SUITE: 627 SQ.FT. | UNITS: #402, 602

IN8

Illustrations are concept only. Plans and specifications are subject to change without notice. Actual floor space may vary from stated floor area. See sales representative for more information. E. & O. E.

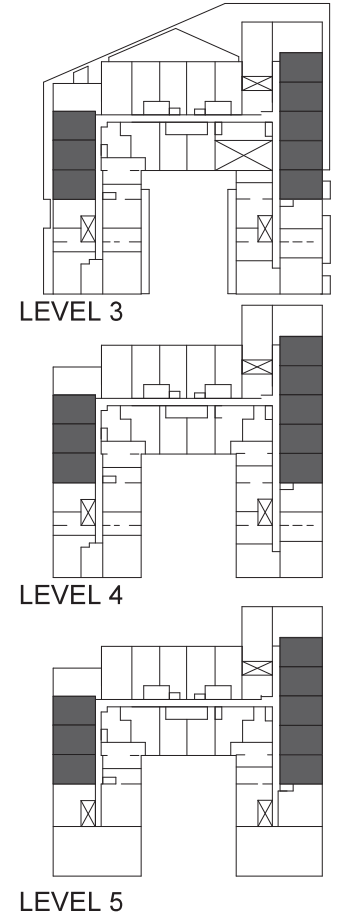
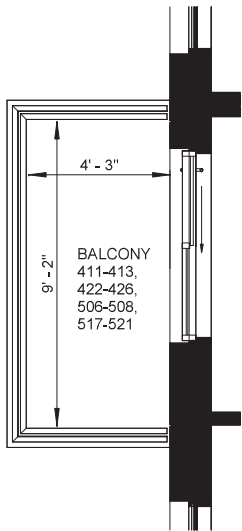

**1107
MAIN**
HAMILTON

2 BED

E599

SUITE: 599 SQ.FT.

TERRACE: 113 SQ.FT.

TOTAL: 712 SQ.FT.

UNITS: #311-313, 322-326

SUITE: 599 SQ.FT.

BALCONY: 51 SQ.FT.

TOTAL: 650 SQ.FT.

UNITS: #411-413, 422-426, 506-508, 517-521

IN8

Illustrations are concept only. Plans and specifications are subject to change without notice. Actual floor space may vary from stated floor area. See sales representative for more information. E. & O. E.

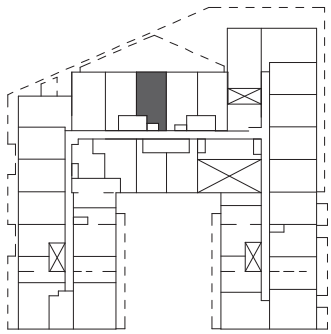

LEVEL 3

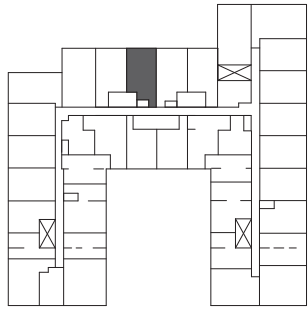

LEVEL 4

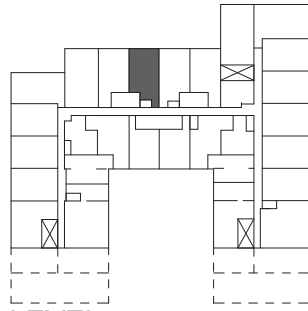

LEVEL 5

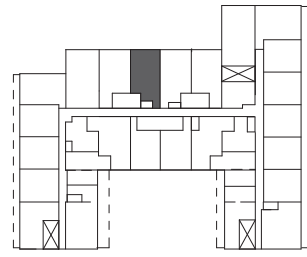

LEVEL 6-7

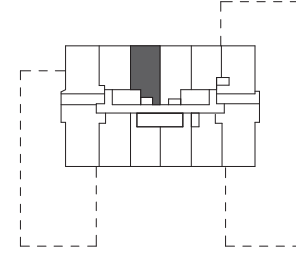

LEVEL 8



NORTH

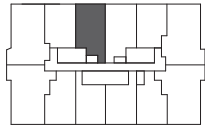

LEVEL 9-12

BALCONY 417, 512, 612,
712, 806, 906, 1006, 1106,
1206

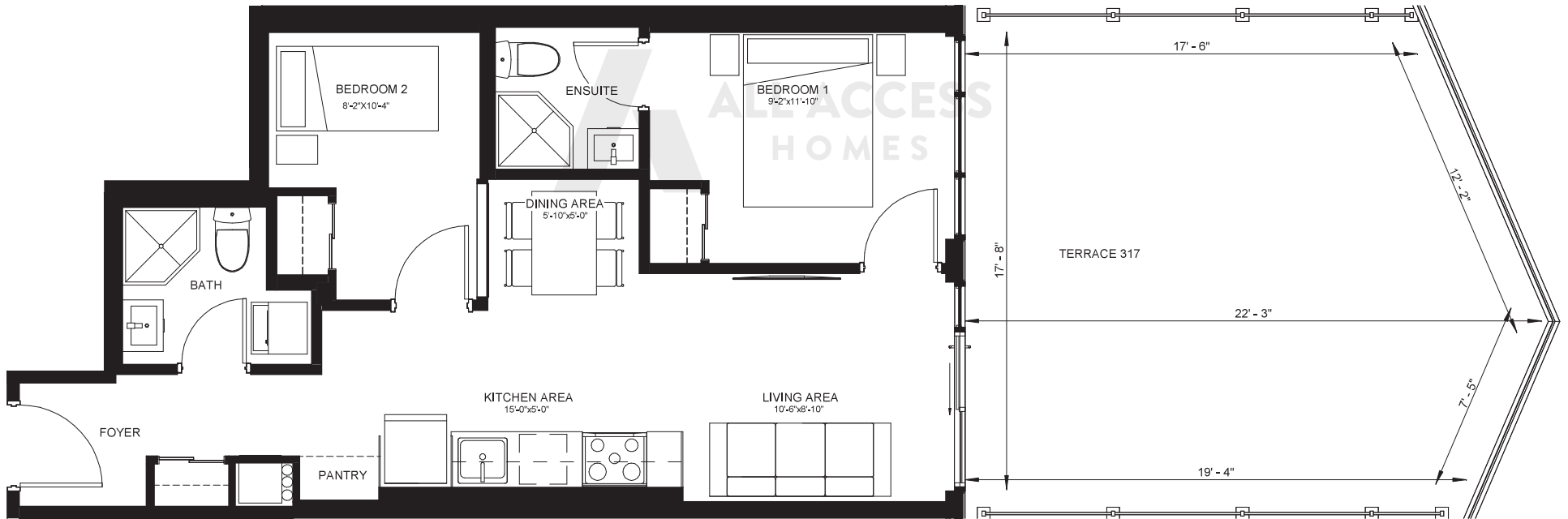
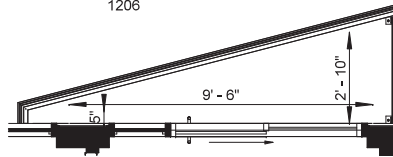

**1107
MAIN**
HAMILTON

2 BED

E613

SUITE: 613 SQ.FT.
SUITE: 613 SQ.FT.
SUITE: 614 SQ.FT.

TERRACE: 304 SQ.FT.
BALCONY: 38 SQ.FT.
BALCONY: 43 SQ.FT.

TOTAL: 917 SQ.FT. | UNITS: #317
TOTAL: 651 SQ.FT. | UNITS: #417, 512
TOTAL: 657 SQ.FT. | UNITS: #712, 806-1206

IN8

Illustrations are concept only. Plans and specifications are subject to change without notice. Actual floor space may vary from stated floor area. See sales representative for more information. E. & O. E.

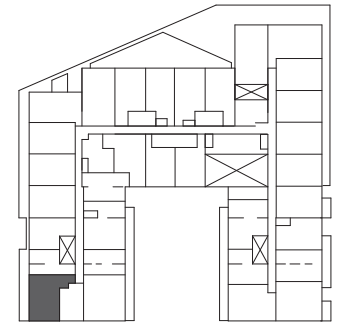

LEVEL 3

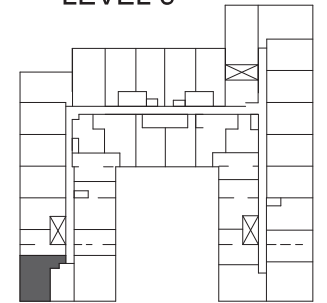

LEVEL 4

**1107
MAIN**
HAMILTON

2 BED

E643

SUITE: 643 SQ.FT. TERRACE: 160 SQ.FT. TOTAL: 803 SQ.FT. | UNIT: #308

SUITE: 643 SQ.FT. BALCONY: 51 SQ.FT. TOTAL: 694 SQ.FT. | UNIT: #408

IN8

Illustrations are concept only. Plans and specifications are subject to change without notice. Actual floor space may vary from stated floor area. See sales representative for more information. E. & O. E.

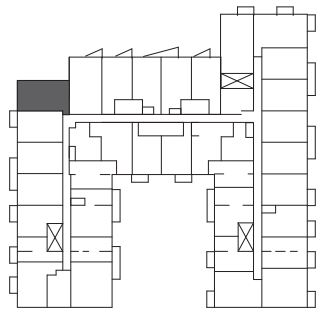
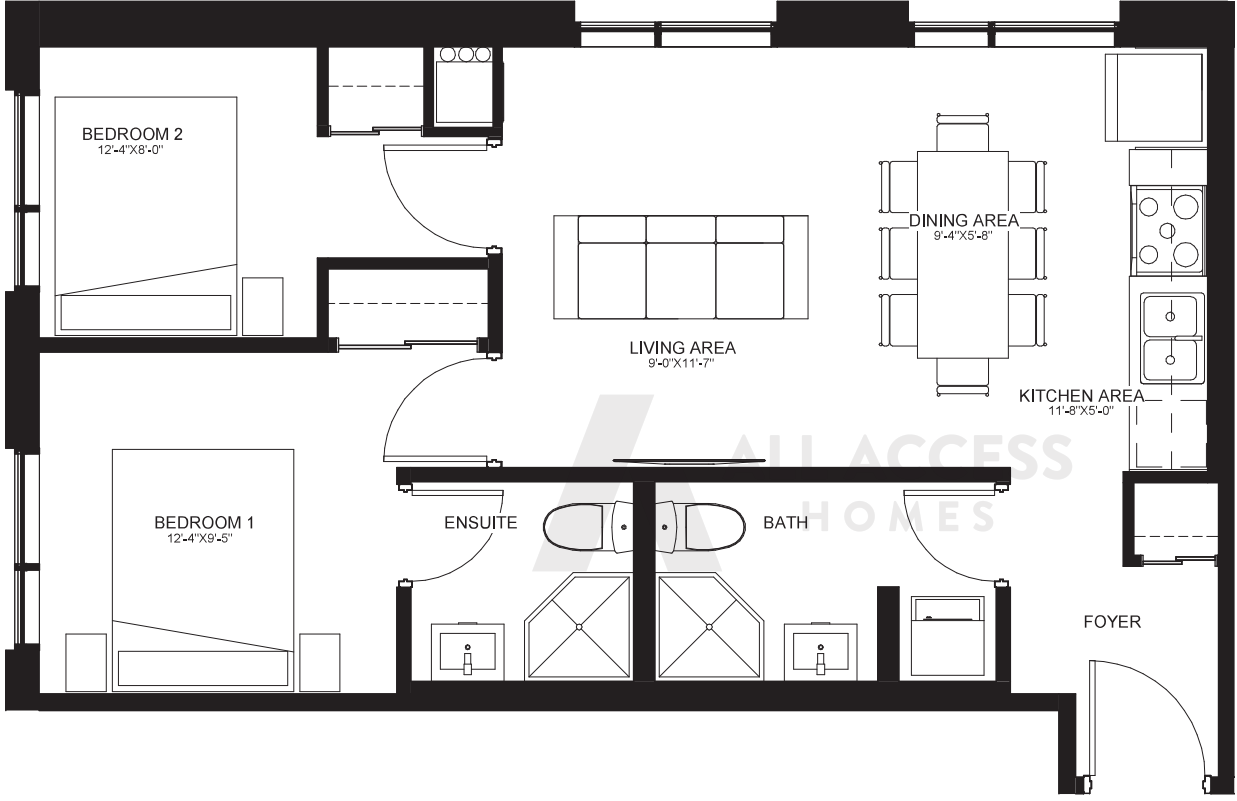

LEVEL 4

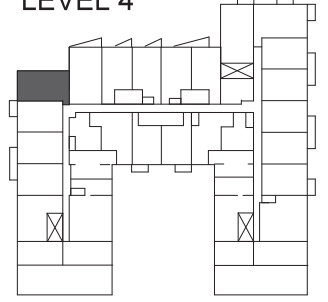

LEVEL 5



2 BED

E669a

SUITE: 669 SQ.FT. | UNITS: #414, 509

IN8

Illustrations are concept only. Plans and specifications are subject to change without notice. Actual floor space may vary from stated floor area. See sales representative for more information. E. & O. E.

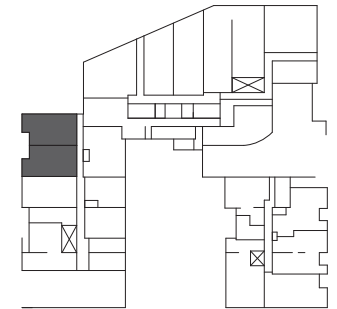
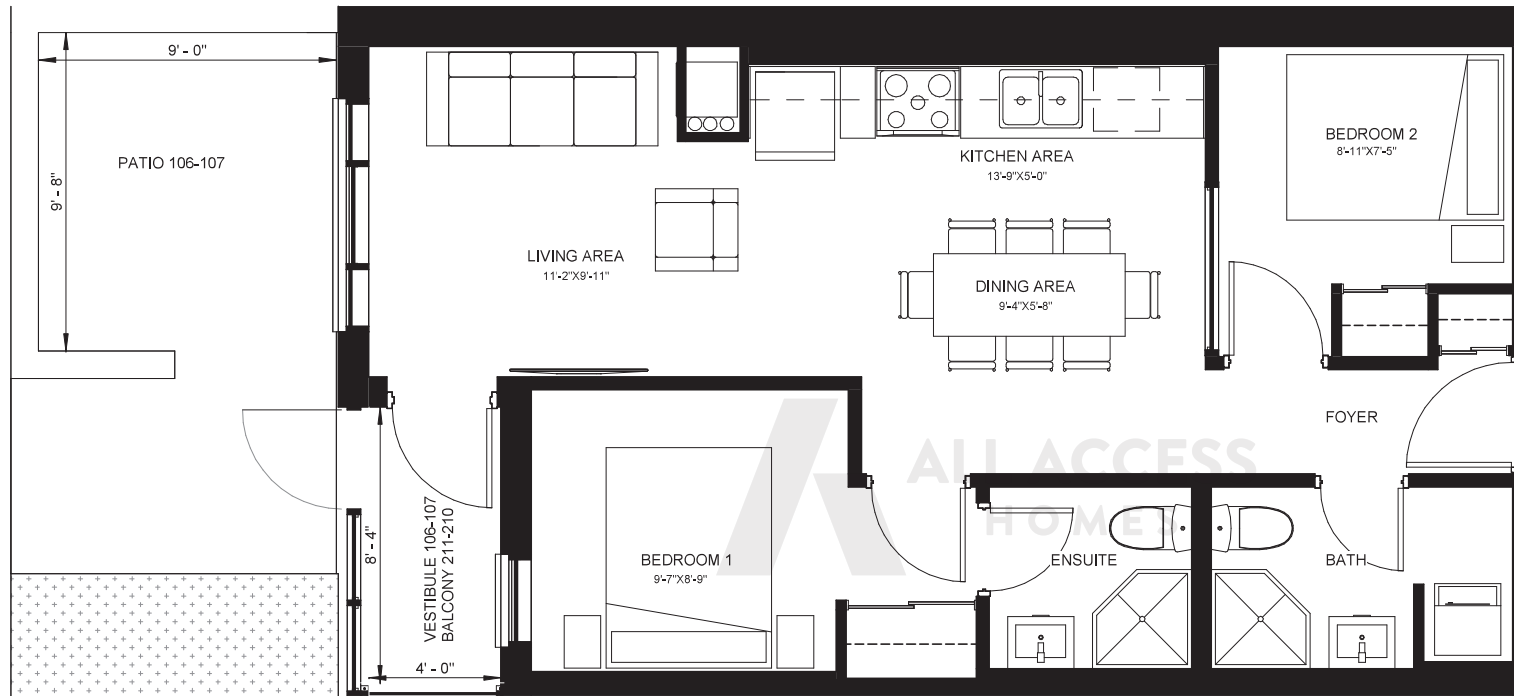

LEVEL 1

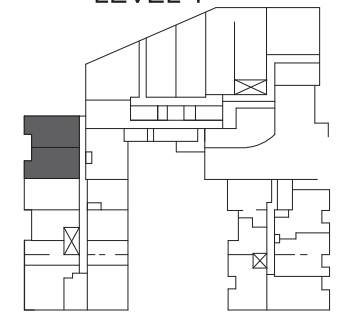

LEVEL 2

**1107
MAIN**
HAMILTON

2 BED

E707

SUITE: 707 SQ.FT. PATIO: 111 SQ.FT. TOTAL: 818 SQ.FT. | UNIT: #107
SUITE: 689 SQ.FT. PATIO: 102 SQ.FT. TOTAL: 791 SQ.FT. | UNIT: #106
SUITE: 707 SQ.FT. BALCONY: 42 SQ.FT. TOTAL: 749 SQ.FT. | UNIT: #211
SUITE: 689 SQ.FT. BALCONY: 42 SQ.FT. TOTAL: 731 SQ.FT. | UNIT: #210

Illustrations are concept only. Plans and specifications are subject to change without notice. Actual floor space may vary from stated floor area. See sales representative for more information. E. & O. E.

IN8

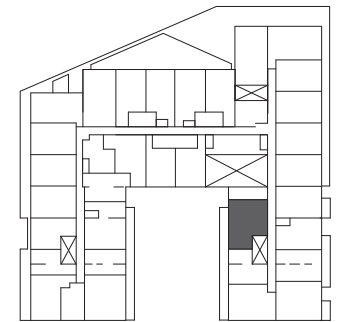

LEVEL 3

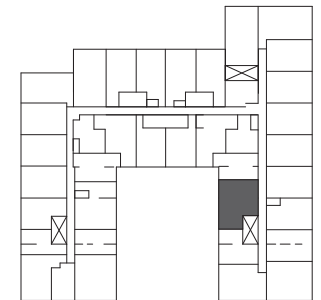

LEVEL 4

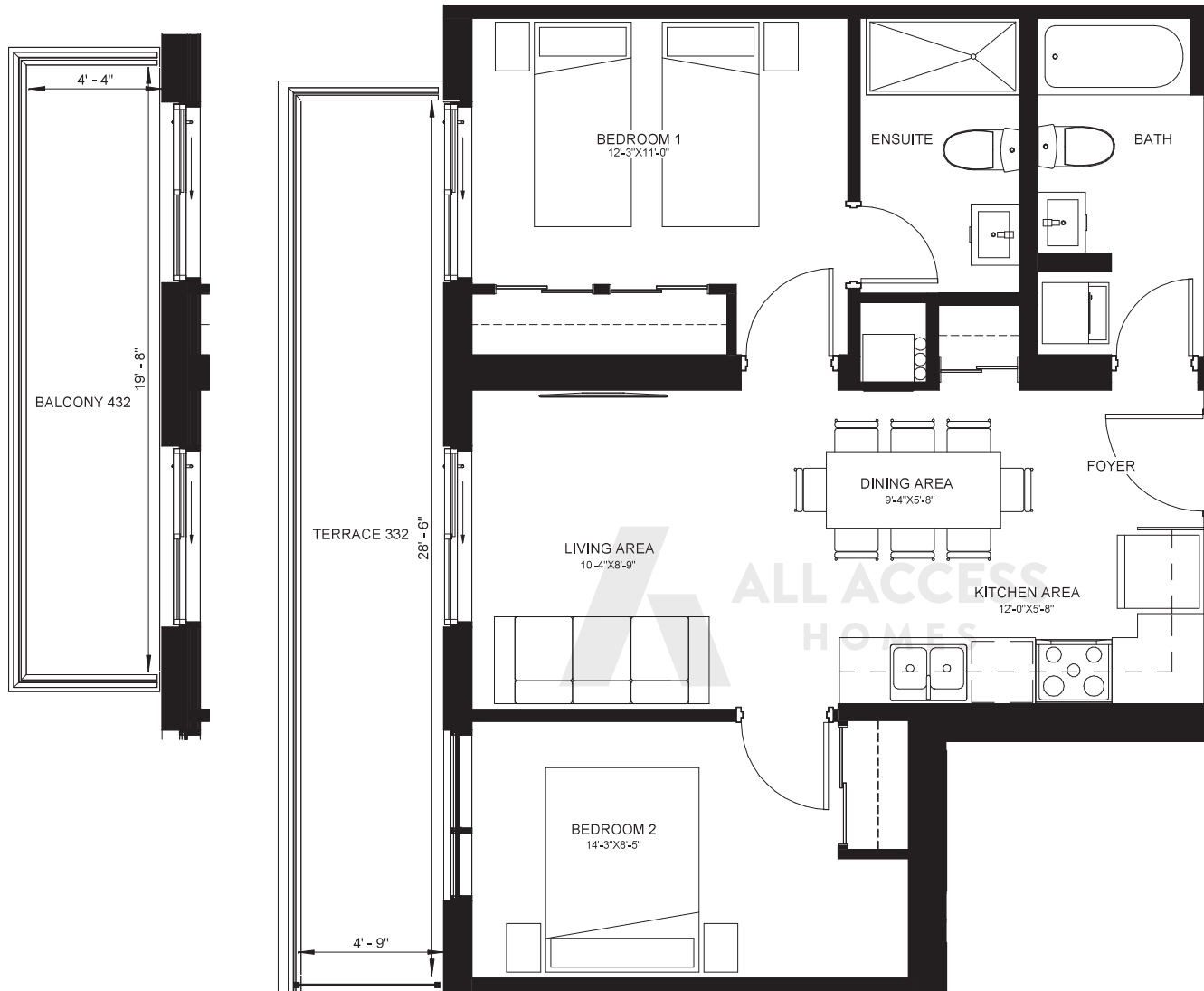

2 BED

E718

SUITE: 718 SQ.FT. TERRACE: 159 SQ.FT. TOTAL: 877 SQ.FT. | UNIT: #332

SUITE: 718 SQ.FT. BALCONY: 52 SQ.FT. TOTAL: 770 SQ.FT. | UNIT: #432

IN8

**1107
MAIN**
HAMILTON

Illustrations are concept only. Plans and specifications are subject to change without notice. Actual floor space may vary from stated floor area. See sales representative for more information. E. & O. E.

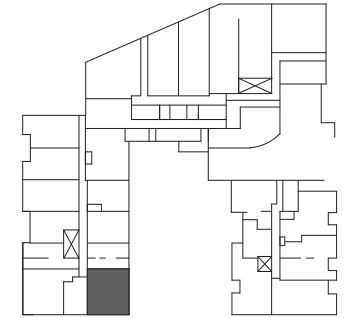
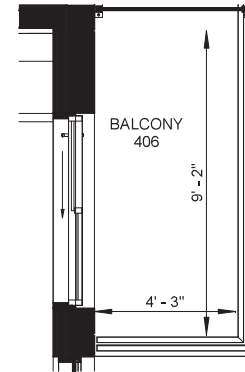
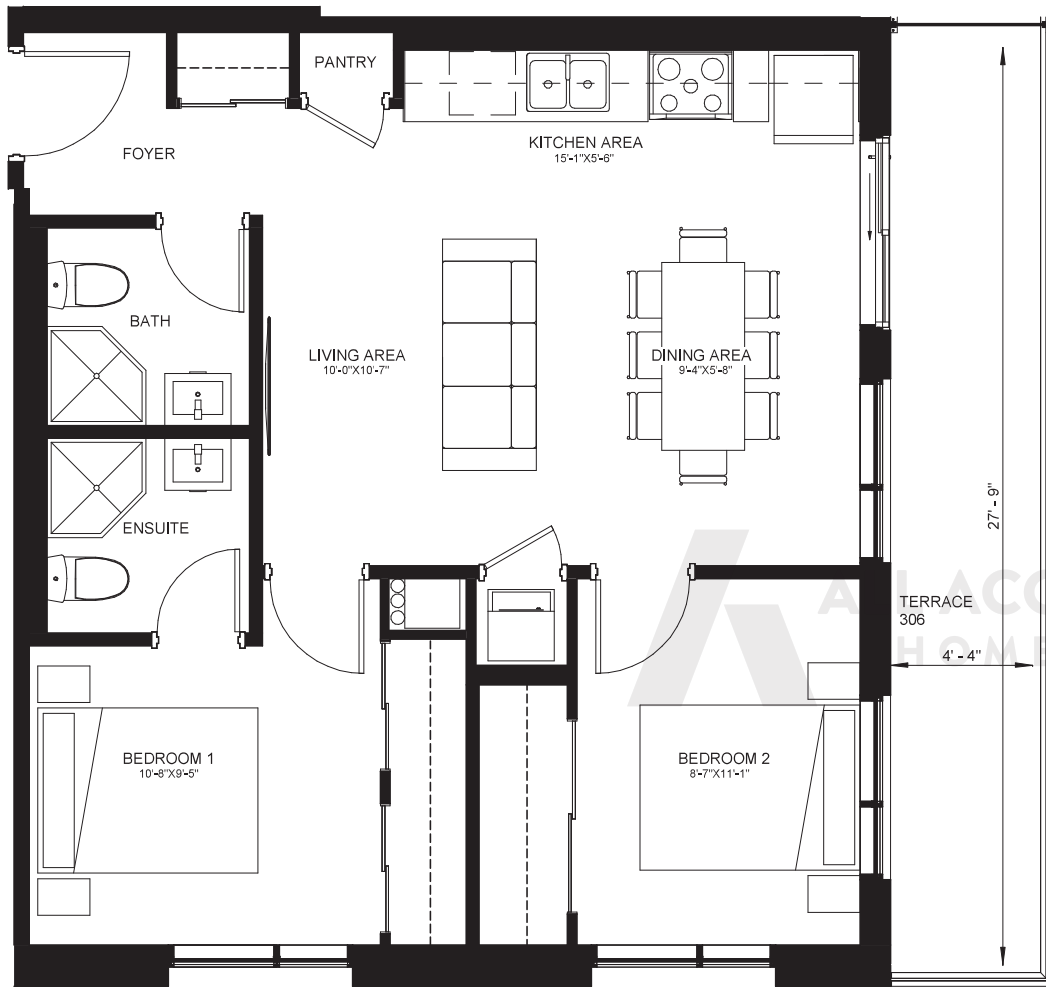

LEVEL 2

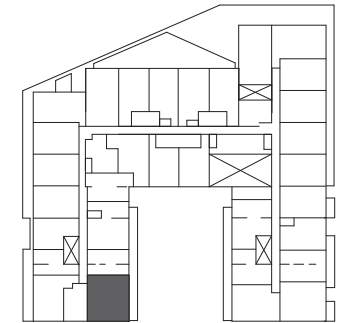

LEVEL 3

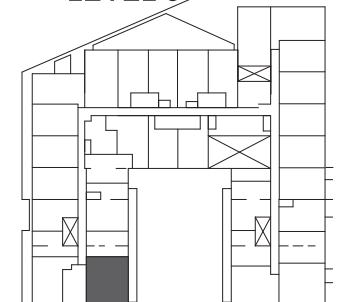

LEVEL 4

**1107
MAIN**
HAMILTON

2 BED

E767

SUITE: 767 SQ.FT. | TERRACE: 144 SQ.FT. | TOTAL: 911 SQ.FT. | UNIT: #306

SUITE: 767 SQ.FT. | UNIT: #204

SUITE: 767 SQ.FT. | BALCONY: 51 SQ.FT. | TOTAL: 818 SQ.FT. | UNIT: #406

IN8

Illustrations are concept only. Plans and specifications are subject to change without notice. Actual floor space may vary from stated floor area. See sales representative for more information. E. & O. E.

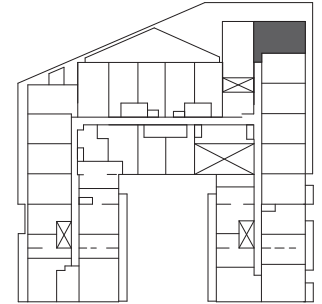

LEVEL 3

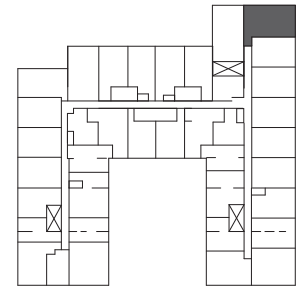

LEVEL 4

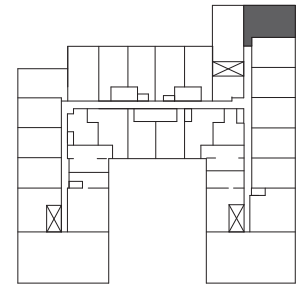

LEVEL 5

1107
MAIN
HAMILTON

2 BED

E780

SUITE: 780 SQ.FT. TERRACE: 207 SQ.FT. BALCONY: 123 SQ.FT. TOTAL: 1110 SQ.FT. | UNIT: #321

SUITE: 780 SQ.FT. BALCONIES: 100 SQ.FT. TOTAL: 880 SQ.FT. | UNITS: #421, 516

IN8

Illustrations are concept only. Plans and specifications are subject to change without notice. Actual floor space may vary from stated floor area. See sales representative for more information. E. & O. E.

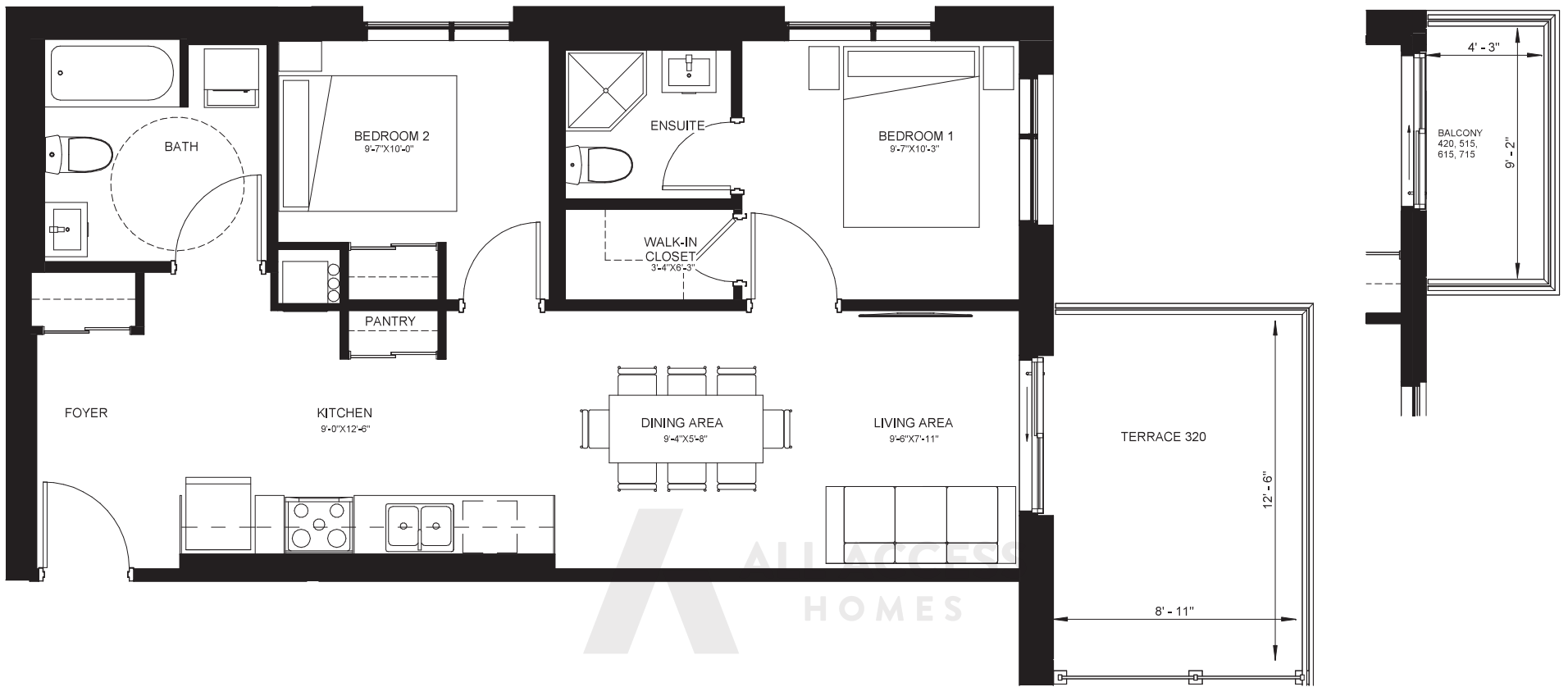

NORTH

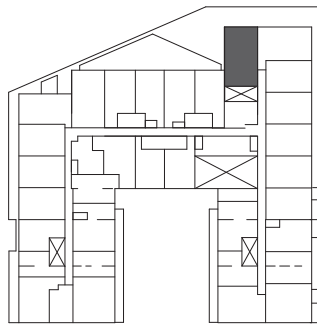

LEVEL 3-4

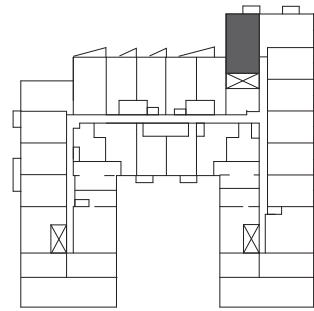

LEVEL 5

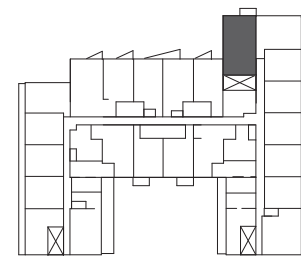

LEVEL 6

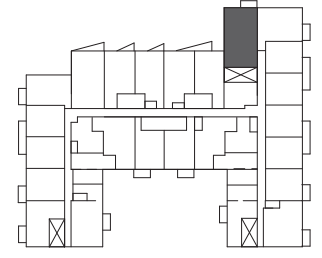

LEVEL 7

**1107
MAIN**
HAMILTON

2 BED

E789

SUITE: 789 SQ.FT.

TERRACE: 132 SQ.FT.

TOTAL: 921 SQ.FT. | UNIT: #320

SUITE: 792 SQ.FT.

BALCONY: 53 SQ.FT.

TOTAL: 845 SQ.FT. | UNITS: #420, 515-715

IN8

Illustrations are concept only. Plans and specifications are subject to change without notice. Actual floor space may vary from stated floor area. See sales representative for more information. E. & O. E.